

# FORMATION AND GROWTH OF TITANIUM ALUMINIDE LAYER AT THE SURFACE OF TITANIUM SHEETS IMMERSSED IN MOLTEN ALUMINUM

R. Khoshhal, M. Soltanieh and M. Mirjalili

*mansour\_soltanieh@iust.ac.ir*

Received: August 2009

Accepted: January 2010

School of Metallurgy and Materials Engineering, Iran University of Science and Technology, Narmak, Tehran, Iran

**Abstract:** In this work, kinetics of intermetallic compounds formation in Al-Ti system was studied by immersing titanium sheets in pure molten aluminum at 750 °C, 850 °C and 950 °C. According to Scanning Electron Microscopy and X-Ray Diffraction Analysis results,  $TiAl_3$  is the only phase can form at the interface. Observations revealed that intermetallic layer thickness increases slowly at primary stages. After that an enhanced growth rate occurs due to layer cracking and disruption. Presumably, reaction starts with solving titanium into the molten aluminum causing in titanium super saturation and  $TiAl_3$  formation. At this stage, growth may be controlled by aluminum diffusion through intermetallic layer which consequently leads to  $TiAl_3$  formation at the interface of Ti- $TiAl_3$ . Furthermore, activation energy of intermetallic layer formation and growth was developed by measuring titanium thickness decreases.

**Keywords:** Intermetallics, Kinetics,  $TiAl_3$ , Titanium Aluminide, Activation Energy.

## 1. INTRODUCTION

Low density, good oxidation resistance and high modulus make titanium aluminide compounds an attractive potential candidate as materials [1]. In the Ti-Al binary phase diagram, several intermetallic compounds appear as equilibrium phases include  $TiAl_3$ ,  $TiAl$ , and  $Ti_3Al$  [2]. Titanium aluminides can be manufactured by fusing methods, however processing problems such as significant difference in melting points of titanium and aluminum, sensibility of these elements to oxidation, high costs and time consumption caused other methods to be interested [3]. One of the alternative methods for manufacturing these compounds is Self-Propagating High Temperature Synthesis (SHS). Recently, SHS has attracted research interests because of its high energy efficiency and productivity, possibility of near net shape forming, etc. The process utilizes heat of formation to maintain self-sustaining characteristics [4]. Munir et al. [5] have investigated reaction mechanism of the field-activated combustion synthesis (FACS) of  $Ti_3Al$  from elemental powders. As they reported combustion reaction is preceded by the melting of aluminum which then spreads over the titanium particles. Liquid aluminum then reacts with titanium giving rise to a layer of  $TiAl_3$  which

grows around the original titanium particles until all of the aluminum is consumed. Subsequently, unreacted titanium reacts with  $TiAl_3$ . The resulting grains consist of titanium cores surrounded by a layer of  $Ti_3Al$  which is followed by a layer of  $TiAl$ . Continuation of this reaction leads to a shrinkage of the titanium cores, the gradual disappearance of the  $TiAl$  layer, and the simultaneous increase in the  $Ti_3Al$  content. A single  $Ti_3Al$  phase is finally obtained.

Sujata et al. [6] have used pure titanium in the form of hot rolled bars and solid aluminum as starting materials to prepare reaction couples. Ti-Al reaction couples were prepared by drilling axial blind holes in titanium bars and then tightly inserting solid aluminum pieces in them. These experiments were designed for temperatures ranging between 700 °C and 1100 °C for time intervals ranging from 0.9 Ks to 7.2 Ks. It is mentioned that the kinetics involves two important steps, chemical reaction to form  $TiAl_3$  and diffusion of aluminum through  $TiAl_3$  to the Ti- $TiAl_3$  interface.

Acoff et al. [7] have used multi-layered Ti-Al composites which were prepared using a cyclic cold roll bonding-annealing process. Their results showed that  $TiAl_3$  forms quite easily at fairly low temperatures in the prior Al-rich layers. This was confirmed by the fact that the entire prior aluminum layers transform to  $TiAl_3$  while the

prior titanium layers react only at the Ti-Al interface and consequently the center of the titanium layers remain pure. They also reported that once  $\text{TiAl}_3$  forms at 650 °C, continuing to hold at this temperature for extremely long times will not promote the formation of TiAl. In addition, Yang et al. [8] have investigated solid state reactive diffusion between titanium and aluminum in the temperature range of 520-650 °C by employing multi-laminated Ti-Al diffusion couples. In the samples annealed up to 150 h,  $\text{TiAl}_3$  is the only phase observed in the diffusion zone. The preferential formation of this compound in Ti-Al diffusion couples was predicted using an effective heat of formation model. This work indicated that both titanium and aluminum diffuse into each other and the growth of the  $\text{TiAl}_3$  layers occur mainly towards the aluminum side. Also, the  $\text{TiAl}_3$  growth changes from parabolic to linear kinetics between 575 and 600 °C, characterized by activation energy of 33.2 and 295.8 KJ/mol, respectively. It is suggested that the low temperature kinetics is dominated by the diffusion of titanium atoms along the grain boundaries of the  $\text{TiAl}_3$  layers, while the reaction at the  $\text{TiAl}_3$ -Al interfaces in the high temperature regime is limited by the diffusion of titanium atoms in the aluminum foils as a result of increased solubility of titanium in aluminum with increasing temperature.

Wei et al. [9] have studied the process of the formation of Ti-Al diffusion bonding joints. Pure titanium and pure aluminum were used as bonding couples. The results showed that the process of joint formation can be separated into four stages and the product of the diffusion reaction is only  $\text{TiAl}_3$  under a particular range of holding time.

In the current work, mechanism and kinetics of reactions between solid titanium and molten aluminum have been investigated by immersing titanium plates into a pure molten aluminum.

## 2. EXPERIMENTAL PROCEDURE

Pure titanium sheets (chemical composition is presented at table 1) and commercially pure aluminum ingots (with purity of 99.6 %) were used in this study. Titanium sheets of 1 cm × 10

**Table 1.** Chemical composition of titanium plates (quantometric analysis results).

Element	Ti	Al	Fe	C	Mo	Mn
wt%	99.4	0.44	0.08	0.06	0.002	0.002

**Table 2.** Times and temperatures applied for immersing titanium plates in molten aluminum.

Temp.	Holding Times (min)									
750 °C	15	20	25	30	60	120	180	240	300	360
850 °C	30	60	100	120	150	180				
950 °C	5	10	15	20	25					

cm were ground by SiC papers and cleaned. 150 g pure aluminum was also cut and melted in an alumina crucible. For this purpose a vertical resistance furnace was employed. Fig. 1 shows the experiments setup in which titanium sheets are immersed into the molten aluminum crucible for different times and temperatures. Designed holding temperatures and time intervals are indicated in table 2. Finally, titanium sheets were withdrawn from melt and cooled in the air.

Samples were cut and mounted to expose the reaction cross section for any observations. Then surfaces were ground and polished. The titanium thickness was measured by means of optical microscopy. Missed titanium thickness was considered as the growth criterion due to high porosity and cracks in intermetallic layer which can lead to miscalculations. It is reasonable that titanium thickness decrease is directly related to titanium dissolution and reaction.

Scanning Electron Microscopy equipped by EDS (ROVENTEC TESCAN) and XRD analysis (PHILIPS TW1800) were utilized to study intermetallic compounds formed at the interface of Al-Ti. 15% HF acid solution was used for

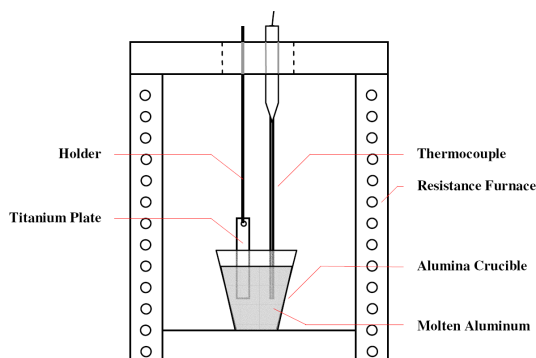

**Fig. 1.** Schematic of experiments setup for immersing titanium sheets in molten aluminum.

eliminating remained aluminum from reaction surface to magnify the intermetallic peaks in XRD analysis.

### 3. RESULTS AND DISCUSSIONS

SEM observations indicated that a thin compound layer has formed in the titanium surfaces since primary times. As illustrated in Figs. 2 - 4, thickness of this layer increases by the time. It is believed that in the prior states, reaction is started by titanium dissolution in molten aluminium causing in intermetallic layer formation. As a result, reaction and intermetallic growth may be dominated by elemental diffusion through the layer.

EDS and XRD analysis indicated that  $TiAl_3$  is

**Table 3.** EDS analysis results for intermetallic layer at points 1 and 2 in Fig. 2-d.

Element	Point 1		Point 2	
	wt%	atom%	wt%	atom%
Aluminum	65.9	77.4	64.7	76.5
Titanium	34.1	22.6	35.3	23.5

the only phase forms in Ti-Al interface. Table 3 shows the EDS results for intermetallic layer at points 1 and 2 in Fig. 2-d.

According to SEM images (Figs. 2-a, 2-b, 3-a, and 4-a), it is obvious that intermetallic layer growth occurred slowly at the initial times. Gradual increasing in thickness leads to layer cracking and disruption due to different molar volumes of the layer compound and titanium. Different molar volumes ( $4.3 \text{ g/cm}^3$  for titanium and  $3.3 \text{ g/cm}^3$  for  $TiAl_3$ ) may result in tensile

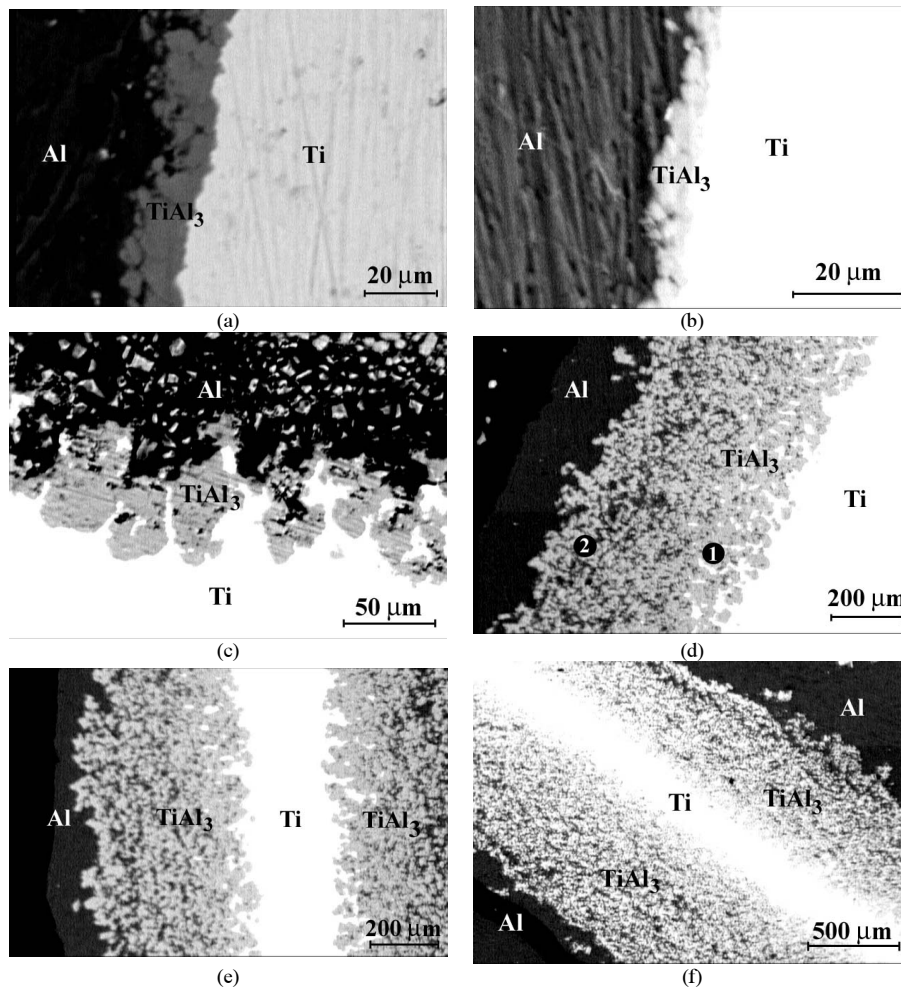

**Fig. 2.** SEM images of titanium sheets immersed in molten aluminum at 750 °C for (a) 10 min, (b) 2 h, (c) 3 h, (d) 4 h, (e) 5 h, and (f) 6 h.

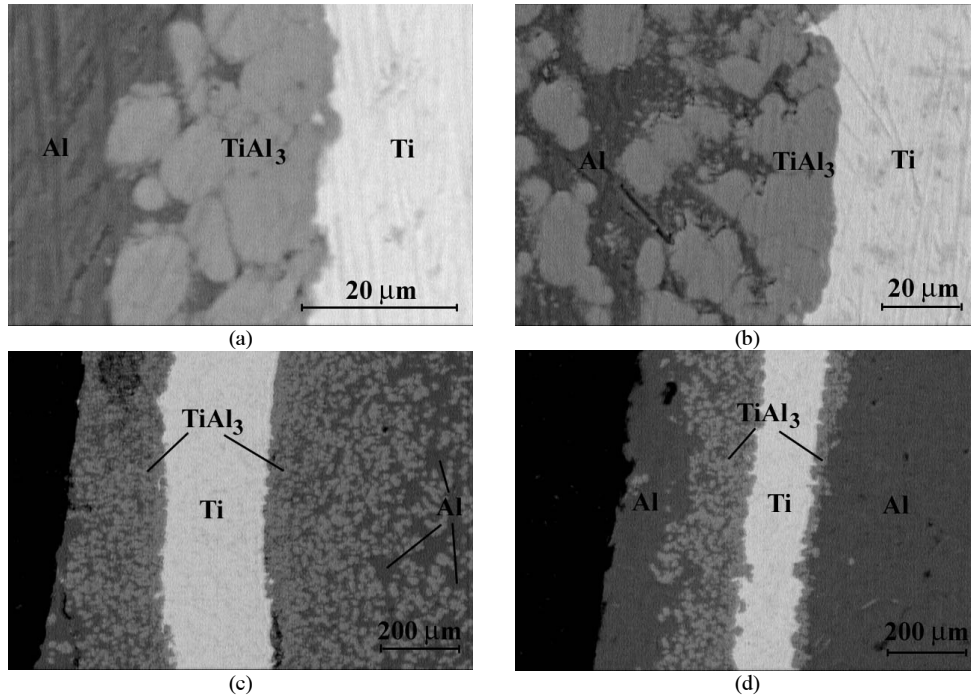

Fig. 3. SEM images of titanium sheets immersed in molten aluminum at 850 °C for (a) 30 min, (b) 1 h, (c) 2 h, and (d) 3 h.

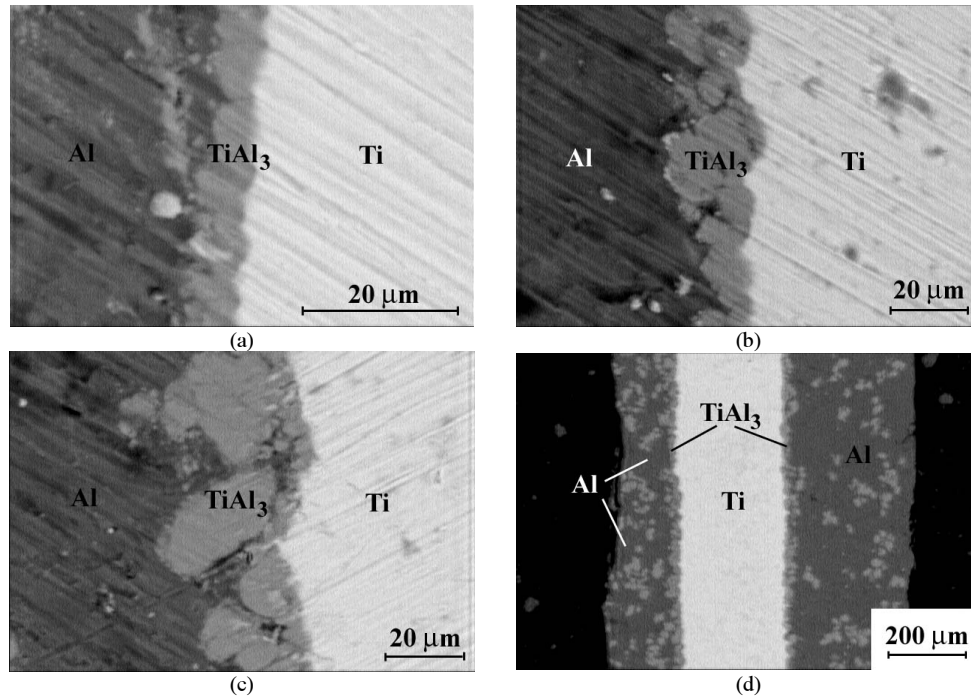

Fig. 4. SEM images of titanium sheets immersed in molten aluminum at 950 °C for (a) 5 min, (b) 10 min, (c) 15 min, and (d) 20 min.

stresses in the Ti-TiAl<sub>3</sub> interface which leads to TiAl<sub>3</sub> layer disruption. Apparently, the layer disruption can lead to a bare titanium surface

which is exposed to molten aluminum and causes in an enhanced layer growth rate.

As illustrated in Figs. 2-c, intermetallic layer

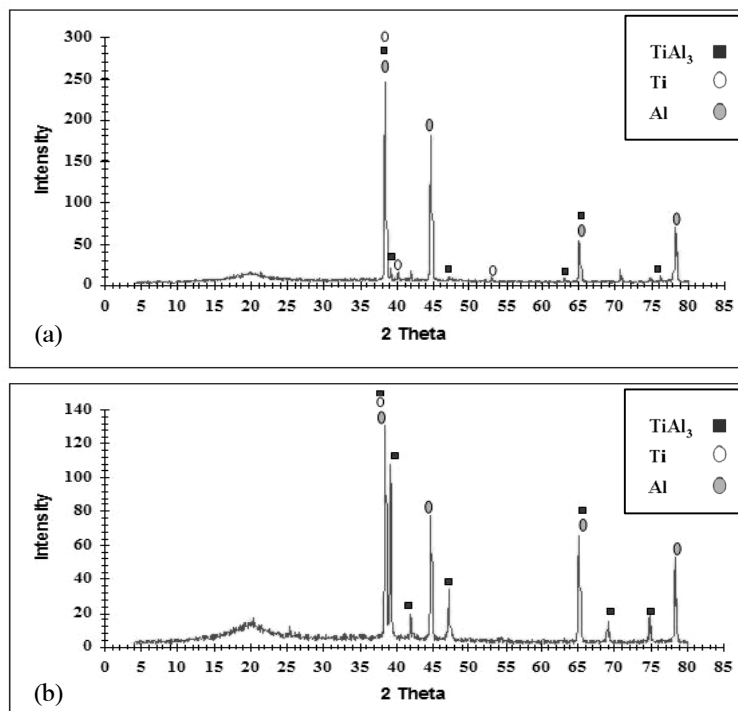

Fig. 5. XRD analysis results for titanium sheets immersed in molten aluminum at (a) 750 °C for 1 h, and (b) 750 °C for 4 h.

thickness is significantly increased by layer disruption. The time when the layer starts to disrupt is dependant to temperature. At enhanced temperatures, shorter times are needed for layer disruption (Figs. 3-c and 4-c).

As reported, aluminum is the dominant diffuser component through the intermetallic layer. Consequently,  $\text{TiAl}_3$  formation and growth occur at Ti- $\text{TiAl}_3$  interface. Aluminum diffusion through  $\text{TiAl}_3$  and titanium can lead to a preferred growth of  $\text{TiAl}_3$  crystals and thus a rough interface. This fact can be found from Fig. 2-c.

XRD analysis was also performed to confirm the EDS consequents. XRD results showed that  $\text{TiAl}_3$  is the dominant compound which can form at the interface of Ti-Al. Fig. 5 indicates XRD results for titanium plates immersed in molten aluminum at 750 °C for 1 and 4 hours. As illustrated,  $\text{TiAl}_3$  amount increases by time.

According to titanium aluminides Gibbs free energies of formation (Fig. 6), it is obvious that  $\text{TiAl}_3$  is the most stable phase can form in Ti-Al system. Therefore, it seems reasonable that  $\text{TiAl}_3$  is the first compound forms between solid titanium and molten aluminum. This fact is in agreement with other experiments which are

reported that  $\text{TiAl}_3$  forms and remains until aluminum exists in the system [5, 8, and 9]. By depletion of aluminum, other intermetallics ( $\text{TiAl}$  and  $\text{Ti}_3\text{Al}$ ) can form.

In current work,  $\text{TiAl}_3$  was the only intermetallic phase which formed at different temperatures and times. It was because of the huge amount of molten aluminum in contact with titanium plates.

Intermetallic layer disruption occurred in longer times, may correspond with the fact that aluminum is the predominant diffusing component through the  $\text{TiAl}_3$  layer. As mentioned, intermetallic layer disruption is occurred due to different molar volumes of titanium and  $\text{TiAl}_3$ , which leads to unadjustment stresses at the Ti- $\text{TiAl}_3$  interface. This phenomenon indicates that  $\text{TiAl}_3$  nucleates and grows at the Ti- $\text{TiAl}_3$  interface causing in interfacial stresses and disruption. Therefore, it seems obvious that aluminum is the only component which diffuses through the intermetallic layer to form  $\text{TiAl}_3$ . This is confirmed by roughness of Ti- $\text{TiAl}_3$  interface which indicates preferred diffusion of aluminum into the titanium. On the other hand, if titanium

diffused dominantly through the TiAl<sub>3</sub> layer, it has been expected to find TiAl at the Ti-TiAl<sub>3</sub> interface due to high concentration of titanium in parts of TiAl<sub>3</sub> layer which are close to interface.

TiAl<sub>3</sub> layer thickness measurement seemed impossible because of the layer disruption. Therefore, titanium thickness decrease was measured to determine reaction and growth kinetics. Titanium thickness measurements (Fig. 7) indicated that increasing applied temperature causes in an enhanced missed titanium thickness due to acceleration of diffusion and reaction rates.

Equation (1) indicates the relation between missed titanium thickness ( $d$ ) and time ( $t$ ).

$$\Delta d = kt^n \tag{1}$$

where  $k$  is rate constant and  $n$  is kinetic exponent. Equation (1) can be rewritten in the following form leading to calculate  $k$ .

$$\ln(\Delta d) = \ln(k) + n \ln(t) \tag{2}$$

Fig. 8 illustrates the variation of missed titanium thickness by time at 750 °C, 850 °C, and 950 °C. According to linear regressions,  $k$  and  $n$  constants can be estimated for applied

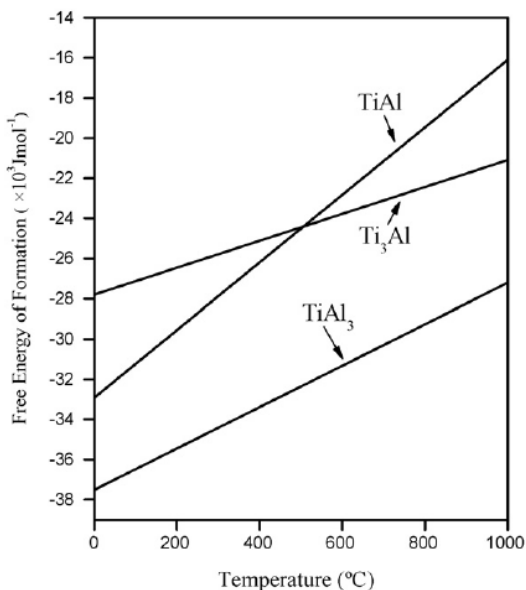

Fig. 6. Gibbs free energies of formation calculated for different types of titanium aluminides [10].

temperatures. Table 4 indicates the calculated values of  $k$  and  $n$  at 750 °C, 850 °C, and 950 °C.

As reported in Table 4,  $n$  values are around 0.5 which corresponds to diffusional processes. As presented, the values of  $n$  decrease by increasing temperature. However,  $k$  values rise at enhanced temperatures, since diffusion and reaction rates increase by temperature.

Equation (3) shows the relation between  $k$ , activation energy ( $Q$ ), and temperature.

$$k = k_0 \exp(-Q / RT) \tag{3}$$

where  $Q$  is activation energy for layer growth,  $R$  is universal gas constant, and  $T$  is temperature. By plotting  $k$  values versus  $1/RT$  (Fig. 9), activation energy ( $Q$ ) can be calculated for TiAl<sub>3</sub> layer formation and growth at the interface of solid titanium – liquid aluminum. As a result, activation energy of 197 KJ/mol is developed.

Table 5 shows activation energies obtained by other researchers for solid titanium and molten aluminum system. By comparing the activation energy calculated in this study with other researcher’s results, it is found that obtained activation energy is close to the value which corresponds to diffusion between Ti–Al through TiAl<sub>3</sub>. As a result, it is reasonable that TiAl<sub>3</sub> layer formation and growth kinetics is dominantly controlled by diffusion of aluminum through TiAl<sub>3</sub>. In contrast, Munir et al. results are not in agreement with current work. It may be because

Table 4. Estimated values for  $n$  and  $k$  at 750 °C, 850 °C, and 950 °C, according to Equation (2).

Temperature (°C)	$n$	$k$
750	0.55	0.93
850	0.42	6.70
950	0.20	41.46

Table 5. Activation energies have been developed for solid titanium and molten aluminum system

Interpreted Kinetic Process	Activation Energy (KJ/mol)	Temperature Rang (°C)	Reference
Ti(s)+3Al(l)=TiAl <sub>3</sub>	97	-	[11]
Diffusion between Ti–Al through TiAl <sub>3</sub>	180	-	[12]
Growth of mixed layer of Al + TiAl <sub>3</sub>	92.4	700 - 920	[5]
Growth by missed titanium thickness measurement	197	750 - 950	Current work

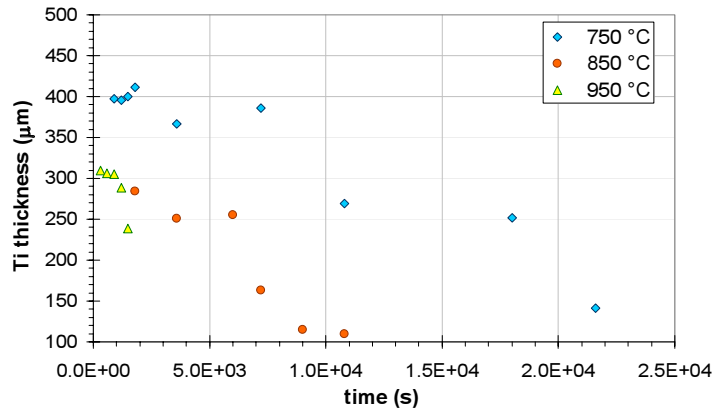

Fig. 7. Thickness of titanium sheets immersed in molten aluminum for different times at 750 °C, 850 °C, and 950 °C.

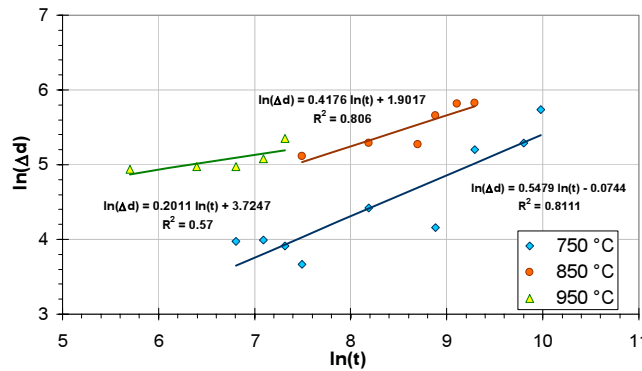

Fig. 8. Missed titanium thickness values versus time at 750 °C, 850 °C, and 950 °C.

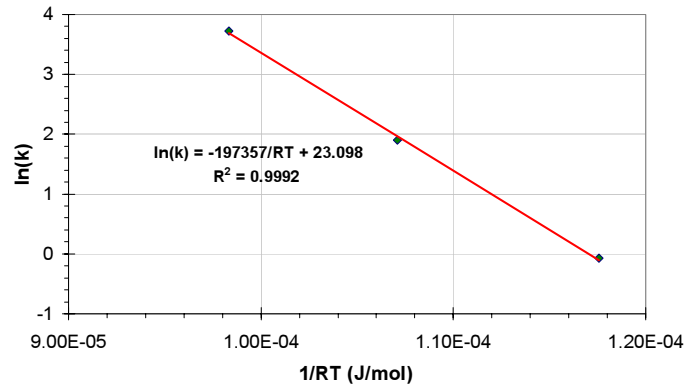

Fig. 9. Growth rate constant (k) versus reciprocal temperature (1/RT) to reveal process activation energy.

of different ways applied in each work to quantify intermetallic layer formation and growth. As mentioned, in the current work missed titanium thickness is considered to determine intermetallic layer formation and growth. It is sensible that growth rate constants (k) obtained by current work are smaller than

Munir et al. results in which thickness of mixed layer of Al+TiAl<sub>3</sub> was considered. In Munir et al. work, disrupted layer (Al+TiAl<sub>3</sub>) thickness has been measured which caused in over estimation of growth rate constants and consequently less calculated activation energy.

#### 4. CONCLUSIONS

1. TiAl<sub>3</sub> is the only intermetallic phase forms at the interface of solid titanium and molten aluminum as far as aluminum exists in the system.
2. At temperatures above aluminum melting point, intermetallic layer growth continues by diffusion of aluminum through TiAl<sub>3</sub>.
3. Activation energy (Q) of 197 KJ/mol was developed for TiAl<sub>3</sub> layer formation and growth at the interface of solid titanium and molten aluminum which may correspond to aluminum diffusion activation energy through TiAl<sub>3</sub> intermetallic layer.

#### REFERENCES

1. Kuang, J. P., Harding, R. A., Campbell, J, *Microstructures and properties of investment castings of  $\gamma$ -titanium aluminide*, *J. Materials Science and Engineering A*, 2002, 329-331, 31-37.
2. Yamaguchi, M, Inui, H., Ito, K., *High-temperature structural intermetallic*. *J. Acta Materialia*, 2000, 48, 307-322.
3. Cao, G. H., Liu, Z. G., Shen, G. J., *Identification of a Cubic Precipitate in  $\alpha$ -Titanium Aluminides*. *J. Alloys and Compounds*, 2001, 325,263-268.
4. Suryanarayana, C., *Non-equilibrium Processing of Materials*, Vol. 2 (Pergamon Materials Series), Pergamon Press, Oxford, 1999, pp. 289-292.
5. Orru, R., Cao, G., Munir, Z. A., *Mechanistic investigation of the field-activated combustion synthesis (FACS) of titanium aluminides*. *J. Chemical Engineering Science*, 1999, 54, 3349-3355.
6. Sujata, M., Bhargava, S., Suwas, S., Sangal, S., *On kinetics of TiAl<sub>3</sub> formation during reaction synthesis from solid Ti and liquid Al*, *J. f Materials Science Letters*, 2001, 20, 2207-2209.
7. Luo, J. G., Acoff, V. L., *Using cold roll bonding and annealing to process Ti/Al multi-layered composites from elemental foils*. *J. Materials Science and Engineering A*, 2004, 379,164-172.
8. Xu, L., Cui, Y. Y., Hao, Y. L., Yang, R., *Growth of intermetallic layer in multi-laminated Ti/Al diffusion couples*. *J. Materials Science and Engineering A*, 2006, 435-436, 638-647.
9. Wei, Y., Aiping, W., Guisheng, Z., Jialie, R., *Formation process of the bonding joint in Ti/Al diffusion bonding*. *J. Materials Science and Engineering A*, 2008, 480, 456-463.
10. Kattner, U. R., Lin, J. C., Chang, Y. A., *Thermodynamic Assessment and Calculation of the Ti-Al System*. *J. Metallurgical and Materials Transactions A*, 1992, 23, 2081-2090.
11. Mackowiak, J., Shreir, L. L., *Kinetics of the interaction of Ti(s) with Al(l)*, *J. the Less Common Metals*, 1968, 15,341-346.
12. Van-Loo, F. J. J., Rieck, G. D. *Diffusion in the titanium-aluminum system-I. Interdiffusion between solid Al and Ti or Ti-Al alloys*. *J. Acta Metallurgica*, 1973, 21, 61-71.